

BioPoly® RS Patella System

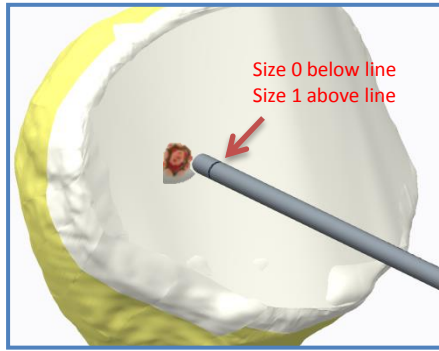

Assess defect depth

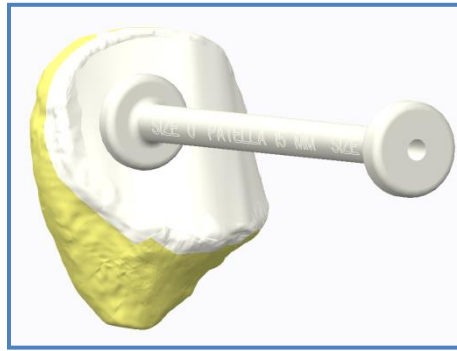

Assess defect size



Place drill guide & insert pilot nail

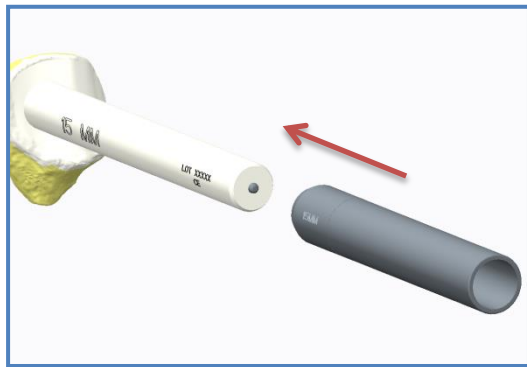

Place guide tube & cut cartilage

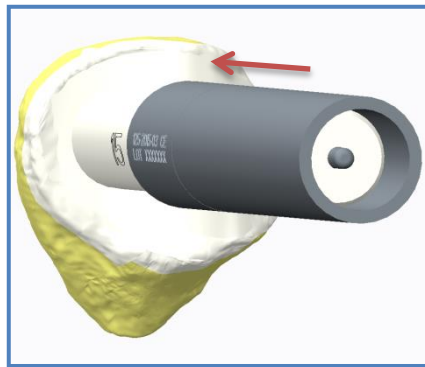

Place reaming cannula

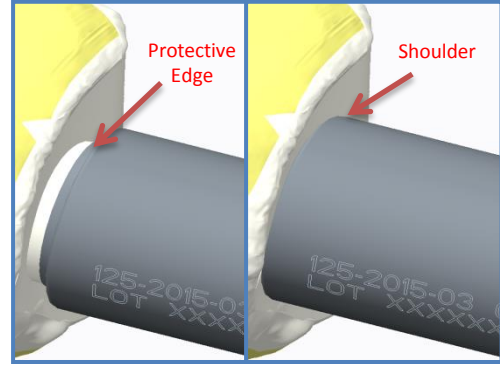

Ensure shoulder resting on cartilage

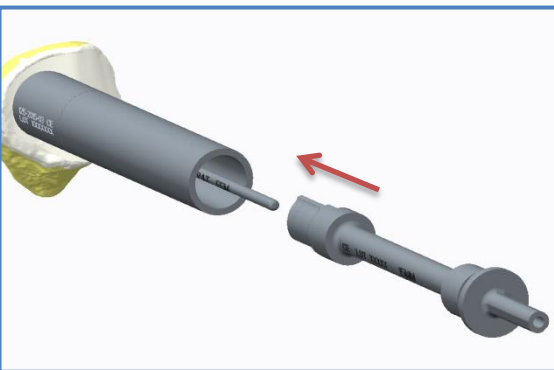

Ream

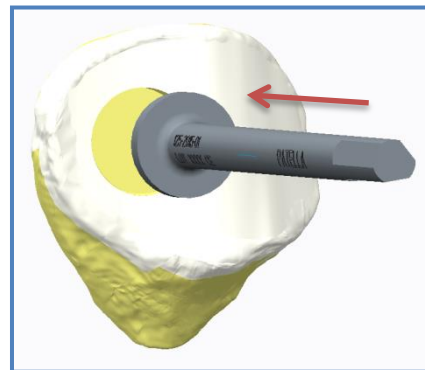

Drill stem hole

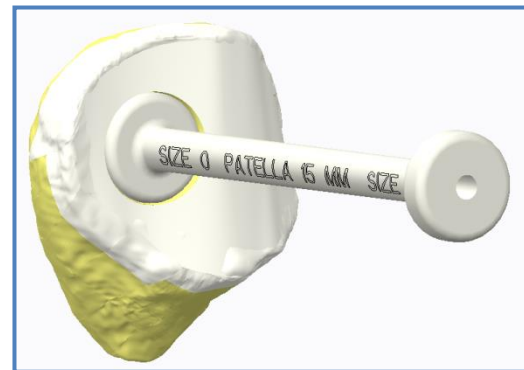

Trial

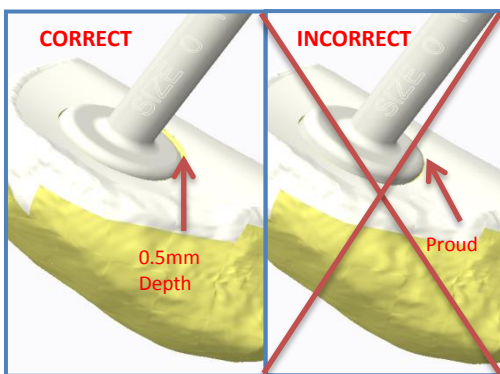

Assess

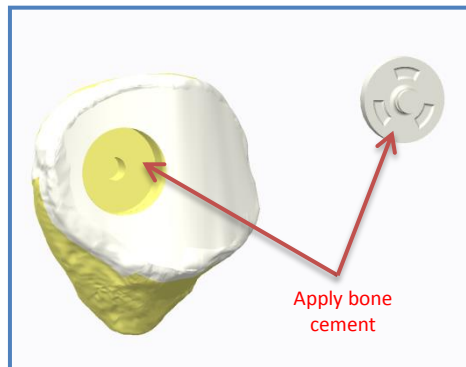

Apply bone cement
push into place

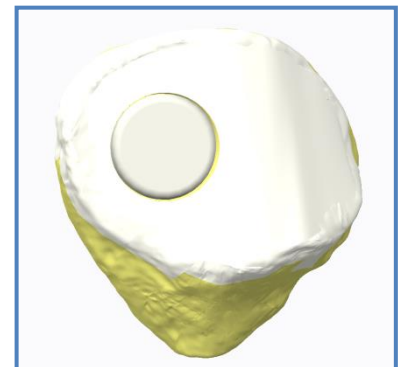

Implant properly placed